

06 dimensions

(size 6 pin housing)

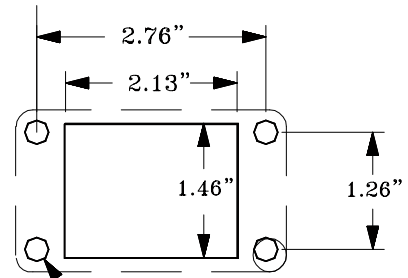
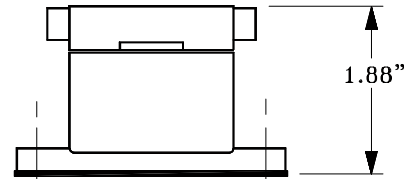
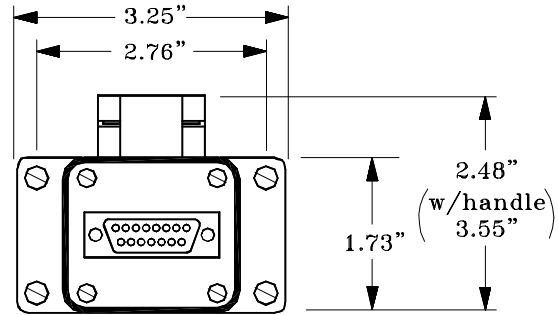

DRILL OR TAP FOR
#8-32 SCREW
(4) PLACES